

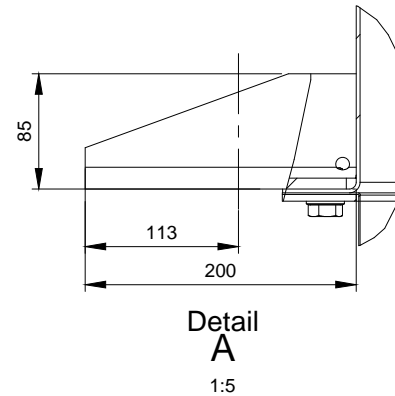

<b>FAN MODEL</b>	<b>MOTOR MODEL</b>
V1M-900	WEG-W22-F180M

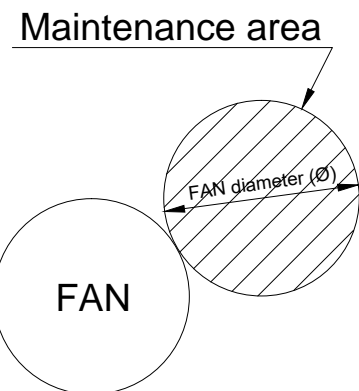
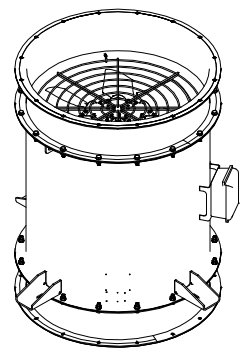
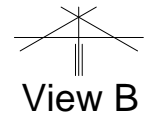
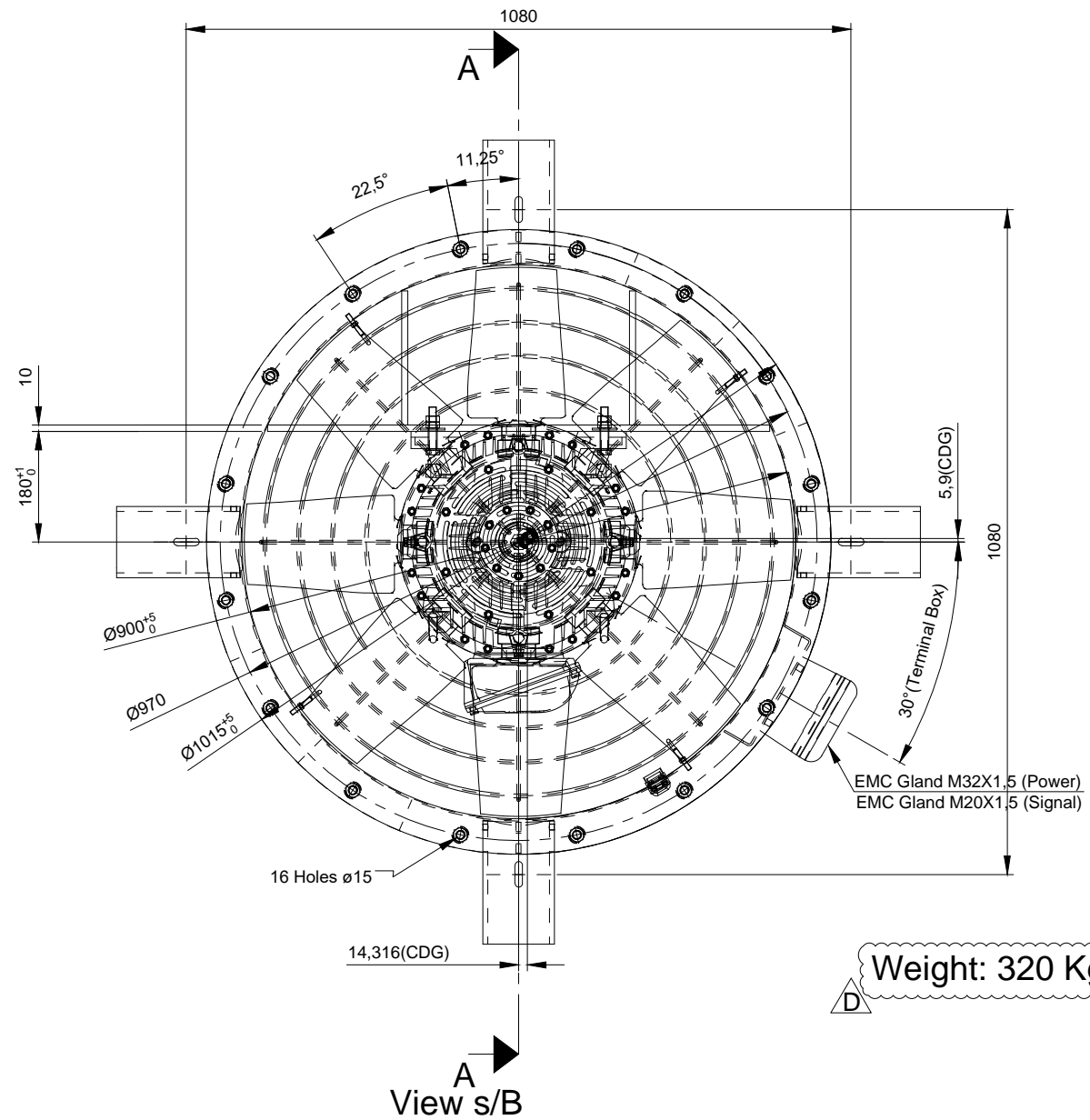
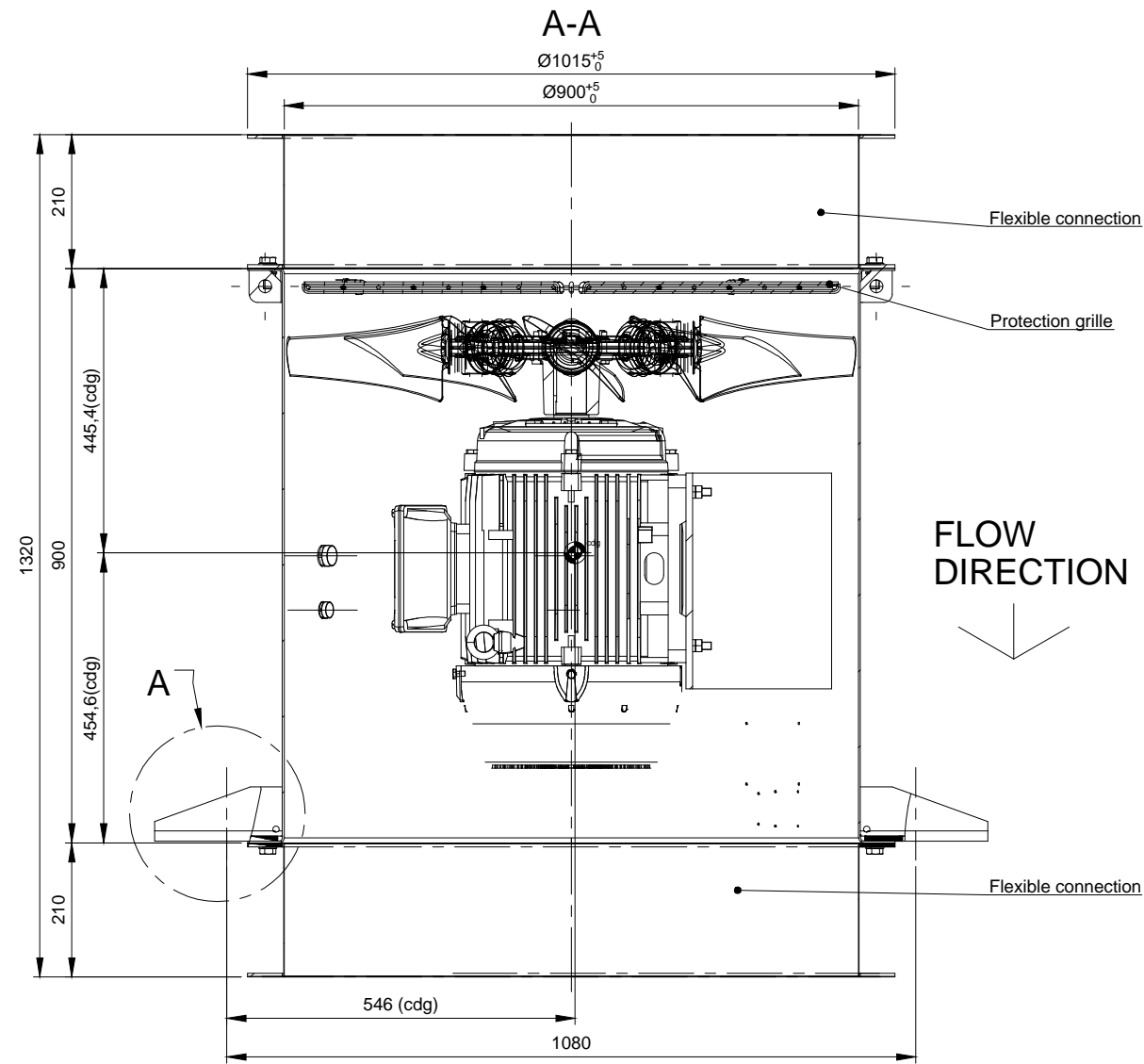

D	UPDATED	09/07/19	JCR	MRH	MRH
C	UPDATED	05/07/19	JCR	MRH	MRH
B	FOR INFO./COMMENTS	10/08/18	JCR	MRH	MRH
A	FOR INFO./COMMENTS	08/08/17	JCR	MRH	MRH
REV.	DESCRIPTION	DATE	DRAWN	VERIFIED	APPROVED

PROJECT:					
AVANTE 2200					
DESCRIPTION:		DRAWING NUMBER:			
MAIN AXIAL FANS FOR ENGINE ROOMS AND DIESEL GENERATOR ROOM		P-M05462-004			
SCALE:	1:10	FORMAT:	A3	SHEET:	01/03